

OZEMTECH™

Röntgen **RO** Compact

Model
WH1122-1800CT-RO

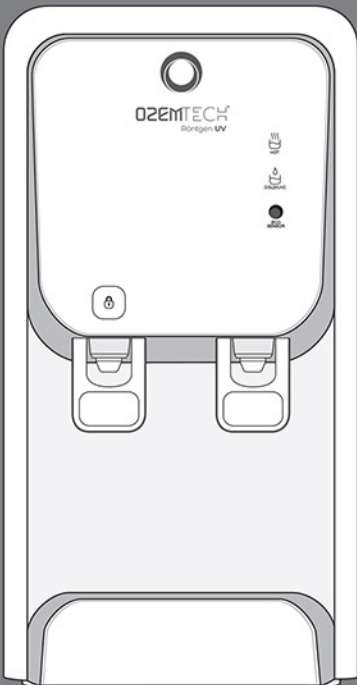

USER MANUAL

CONTENTS

FOR YOUR SAFETY

Precautions 03

FOR INFORMATION

Parts of Röntgen RO Compact 08

Filtration System 09

How to Use 10

ECO/UV System 12

Filter Replacement Guide 13

Hot Tank & Cold Tank Cleaning 14

Features 15

Troubleshooting 16

Specifications 18

Warranty Card 19



Please read the following precautions carefully to avoid dangers and damages.

There are three types of precautions depending on the degree of danger and damage that occur by improper use:

If not observed, serious injury or even death could occur.

If not observed, serious injury or damage to property could occur.

If not observed, slight injury or damage to property could occur.

*This symbol notifies the dangers caused by improper use.
Please read carefully and follow the precautions.*

Precautions for Power Supply



Plug the power cord into an AC220V outlet only.

❖ Failure to do so can cause fire and/or electric shock.



Clean the plug before using it by wiping off any dust and/or foreign particles.

❖ Failure to do so can cause fire and/or electric shock.



Do not use the plug if it is damaged and/or if the wires are exposed from the cord.

❖ It can cause fire and/or electric shock and may also result in water leakage.
❖ Please contact **OZEMCare** CCASSC for repair and replacement.

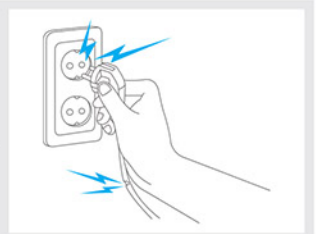

Unplug the power cord before replacing filters.

❖ Failure to do so can cause fire and/or electric shock.

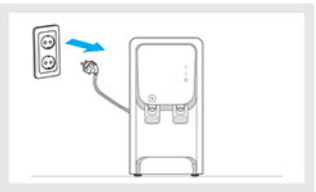

PRECAUTIONS



Do not bend, tie or pull the power plug by its cord.

❖ *It can cause fire and/or electric shock.*

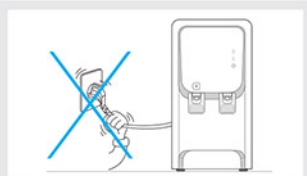

The outlet should be for more than 10A. Use a separate outlet for the unit.

❖ *Overloading an outlet with too many plugs may cause fire and/or electric shock.*

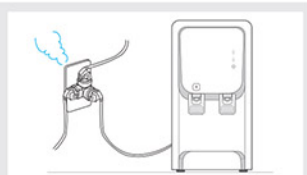

Do not modify or disassemble the plug.

❖ *It can cause fire and/or electric shock.*



Do not plug and unplug the power cord with wet hands.

❖ *It can cause fire and/or electric shock.*



Precautions for Installation



Do not install this unit in a moist or wet environment, such as bathrooms, shower rooms, and/or outdoors.

❖ *It can cause fire and/or electric shock.*



Do not bend or twist the inlet hose.

❖ *It can cause low water pressure to no water flow to the unit.*

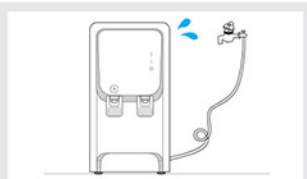



Do not install this unit under direct sunlight and avoid high heat areas.

❖ *It can cause the deformation of the unit exterior.*

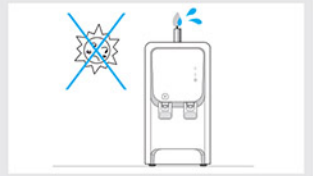

Do not place the unit on a bumpy or uneven surface floor.

❖ *It can cause malfunction.*



Do not connect to a hot water supply.

❖ *It can cause damage to filters and/or result in poor performance.*



The unit must be at least 20cm away from the wall to allow for proper ventilation.

❖ *Failure to do so can cause overheating and malfunction.*

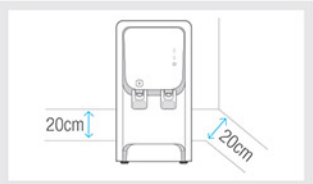

Precautions for Use



Do not place heavy objects on top of the unit.

❖ *It can cause damage to the product.*



Do not Turn ON the power when water supply is cut off.

❖ *It can cause malfunction.*

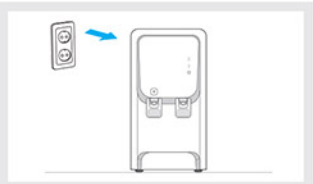

PRECAUTIONS



Do not apply unnecessary force when using the unit.

❖ *It can cause malfunction, damage, and/or electric shock.*

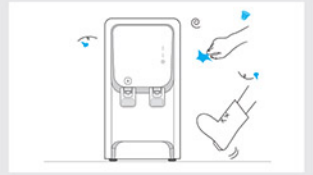

Do not attempt to repair, disassemble or modify the unit. This may void any product warranty unless done by an authorized technician following OZEMTECH User Manual.

❖ *It can cause fire and/or electric shock.*

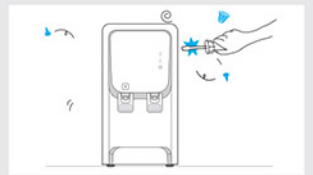

Do not insert sharp wires and/or screwdrivers into the unit.

❖ *It can cause malfunction and/or electric shock.*

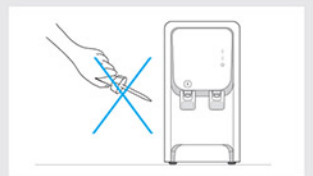

Do not touch hot water and be careful when handling it.

❖ *It can cause severe burns and/or bodily harm.*

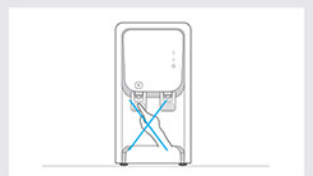

Do not tilt the unit more than 45° while in transit.

❖ *It can cause malfunction.*

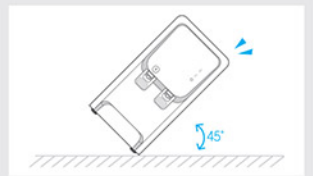

Do not move the unit while it is in operation, connected to water, and power supply.

❖ *It can cause malfunction.*





Do not use Benzene or gasoline when cleaning the unit.

❖ *It can cause discoloring, peeling and/or damage to the exterior of the unit.*



Unplug power and **Shut OFF** water supply when not in use for a long period of time. (Make sure to drain out the water reservoir in tanks before re-using the product after a long time of non-use.)

❖ *It can cause fire and/or water leakage.*

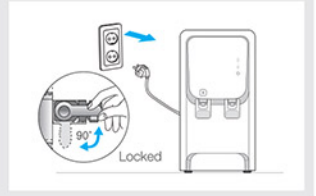

Make sure that the Cold Water Tank lid is securely shut before using.

❖ *Failure to do so can cause insects and/or foreign objects to enter the tank.*

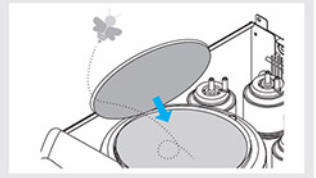

❖ *This unit is not intended for use by people (including children) with reduced physical, sensory or mental capabilities, or lack of experience and knowledge unless they have been given supervision or instruction concerning the use of the unit by a person responsible for their safety.*

❖ *Children should be supervised to ensure that they do not play with the unit.*



When discarding parts/filters and/or disposing the unit entirely, please adhere to local guidelines.

❖ *Failure to do so can cause environmental pollution.*



When installing the unit, always use genuine parts.

❖ *Failure to do so can cause water leakage or damage to the unit.*



When replacing filters, always use genuine filters.

❖ *Failure to do so can cause poor performance and poor water quality.*



Do not install the water dispenser in severe and extreme temperatures.

❖ *It can cause overheating or freezing.*

PARTS OF RÖNTGEN RO COMPACT

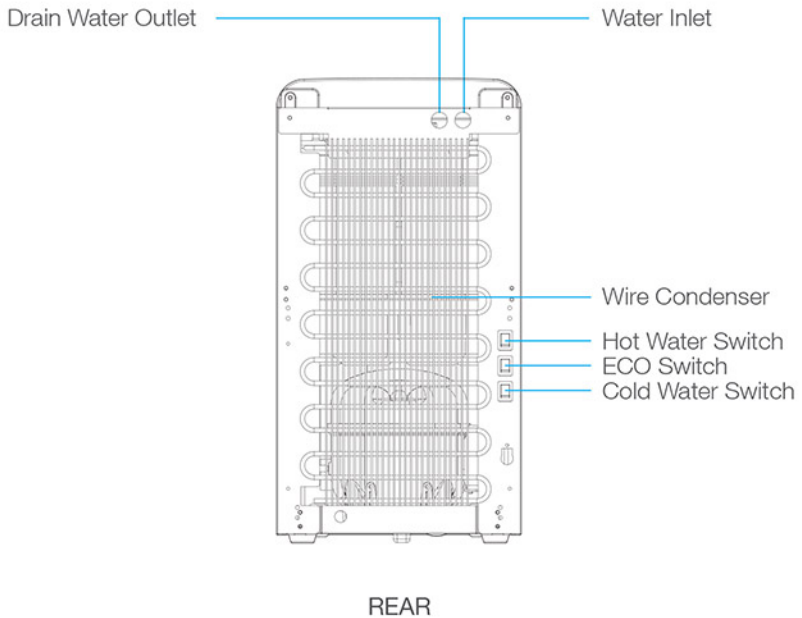
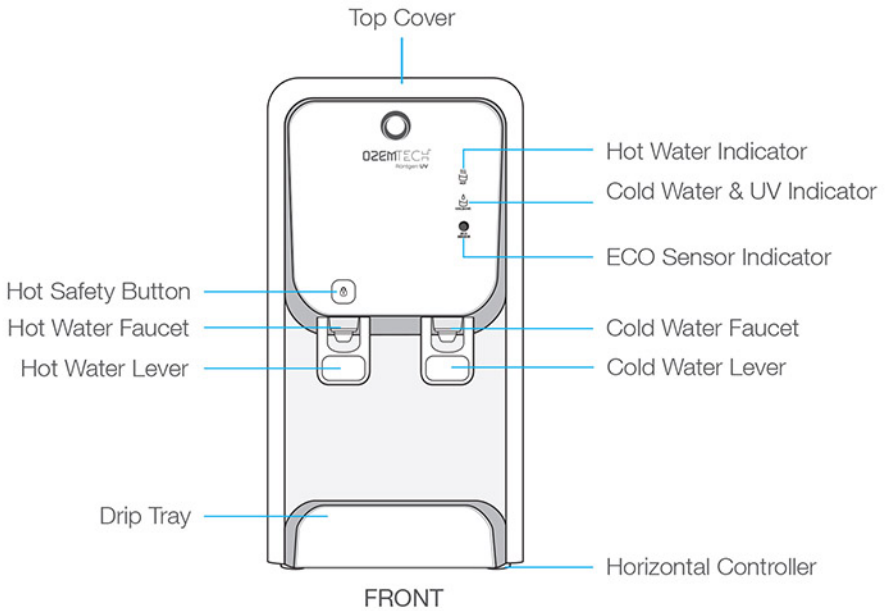

FILTRATION SYSTEM

INTERIOR DIAGRAM

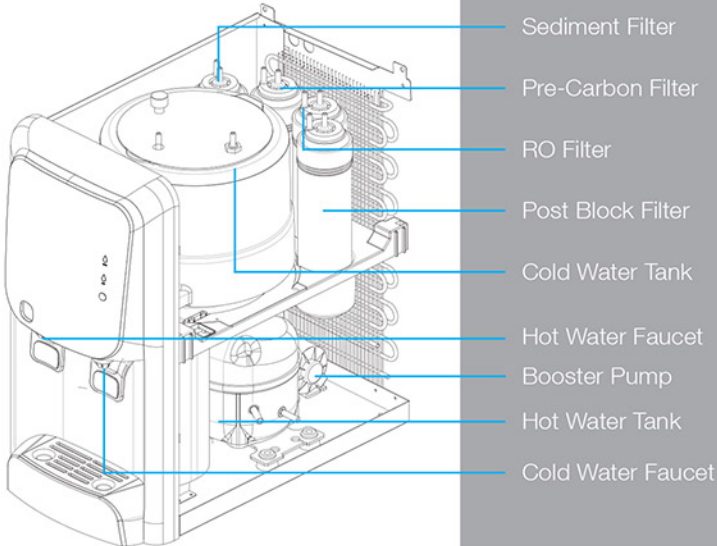

WATER FILTRATION PROCESS

	1 STEP	2 STEP	3 STEP	4 STEP
Filter Name	Sediment Filter	Pre-Carbon Filter	RO Filter	Post Block Filter
Expected Replacement	Estimated 6 months	Estimated 6 months	Estimated 12 months	Estimated 12 months

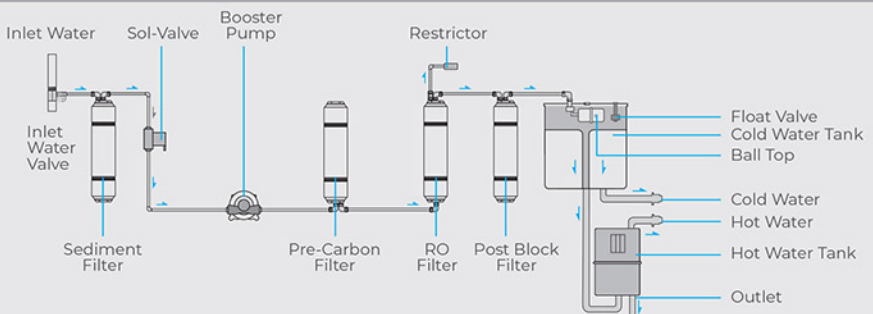

- ❖ Consumable parts (such as fitting, tubing, float valve, etc.) are required to be replaced approximately every 2 years. Failure to replace these parts can cause property damage by water leakage.
- ❖ When using or replacing new filters, all filters must be flushed properly.
Please contact **OZEMCare** Customer Care & After-Sales Support Center for proper filter flushing guidelines.

HOW TO USE

1 PLUG THE POWER CORD TO OUTLET

- ❖ Before plugging, check if the voltage rate is matched.
- ❖ **Turn OFF** the Hot Water Switch before plugging in.

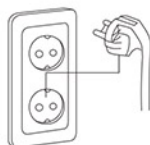

2 OPEN THE WATER SUPPLY VALVE

- ❖ If Water Supply Valve is closed, the water dispenser does not work.
(Except in cases of going out for a long time, leave the valve open.)

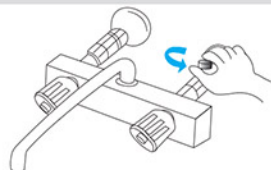

3 HOW TO USE

A - How to use Hot Water Function

- Turn ON** the Hot Water Switch located at the back of the unit.
 - Hot Water Indicator will light up and heating will begin.
 - Allow approximately 30 minutes for the hot water to heat up after the switch is turned on.
 - Allow sufficient time for the hot water tank to fill up with water.
 - How to dispense Hot Water
 - Press the Hot Water Safety Lock and then push the Hot Water Lever to dispense hot water.
 - To stop dispensing hot water, pull your hand away from the Hot Water Lever.
- ❖ *When hot water is not needed, **turn OFF** the Hot Water Switch to reduce power consumption.*

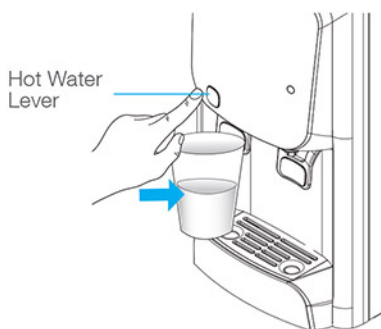
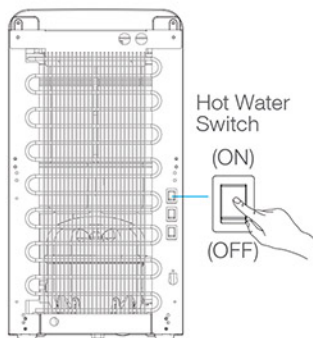

B - How to use the Cold Water Function

- i - **Turn ON** the Cold Water Switch to enable chilling.
- ii - Please allow approximately 60 minutes to chill the water in the Cold Tank.
- iii - How to get cold water
 - Push the Cold Water Lever to start dispensing cold water.
 - To stop dispensing cold water, pull your hand away from the Cold Water Lever.

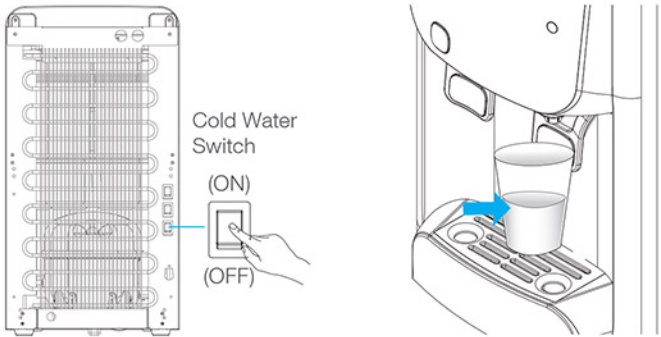

C - How to enable Continuous Cold Water Dispensing

- Pull the lever forward to dispense cold water without stopping.
- Return the lever to its original position to stop water dispensing.

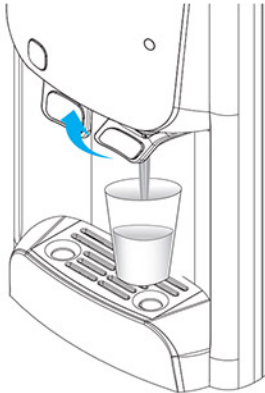

Before turning on the Hot Water Switch, make sure that water is coming out of the Hot Water Nozzle.

❖ *Failure to do so can cause malfunction.*

- ❖ After installation of the unit, the drain first 20 liters of water.
- ❖ If you do not use the water dispenser for a prolonged period, drain 1~2 liters of water before use again.

ECO SYSTEM

What is ECO (illuminance sensor) function?

- ❖ ECO function helps save power consumption by sensing illuminance around the unit. When the illuminance around the unit darkens at night, the unit automatically stops water heating and chilling and adjusts the brightness of the display.
- ❖ When the illuminance around the unit brightens again, the sensor automatically stops ECO function, and the unit work normally.
 - About 20 minutes for hot water and 60 minutes for cold water are required to turn the hot and cold water temperature back to normal.
 - While the ECO function is being operated, ECO indicator flickers and the other lamps darken.

How to operate ECO function (illuminance sensor)

- ❖ Turn ON the ECO switch at the back of the unit.
- ❖ You can check if the amber light turns ON in the Hot Water lamp.
- ❖ When activated, the green light turns ON in the Hot Water lamp.

Precautions for operating ECO function

Because the ECO function is operated by sensing illuminance around the unit, do not install it in a dark or shady place. (ECO function may be operated at all times. Water heating and chilling may not work.)

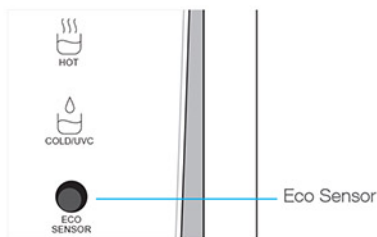

UV LED SYSTEM

- ❖ UV LED sterilization is operated initially when the electronic power cord is plugged in. There is no

ON/OFF switch for UV LED operation and it is operated automatically. The function of UV LED could deteriorate 5 years later after use. During the operation of UV LED, the UV indicator flickers on and off. The UV indicator for this unit is embedded in the Cold Water indicator as shown in this illustration.

- ❖ Sterilization Cycle: 2 hours/1 day
 - ❖ Make sure to unplug the power cord when opening the tank lid.
 - Failure to do so can lead to an accident caused by the light of UV LED in the Cold Tank.

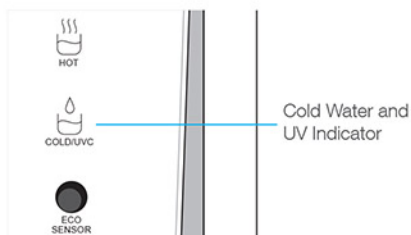

FILTER REPLACEMENT GUIDE

1

Shut OFF Water Supply and unplug the power cord, before replacing new filters.

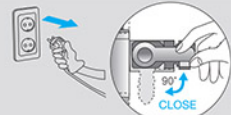

Water Supply Valve

2

Remove both left and right screws located at the back of the unit to remove the top cover.

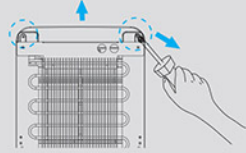

3

Remove the old filters with a Fitting Separator/ Flat Screw Driver and insert the new filters in reverse order.

- ❖ Always check for water leakage after replacing filters.
- ❖ Make sure that each filter is in the proper order of filtration process.

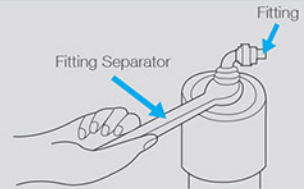

4

Once all the filters have been replaced securely, make sure to open the Water Supply Valve and plug the power cord back into the outlet.

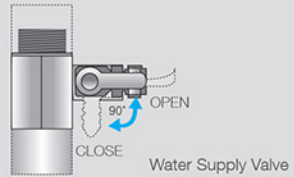

❖ *Before replacing any filters, always pull out the power cord and close the Water Supply Valve.*

- When using the unit for the first time or replacing the filter, do water flushing process to each filter for more than 10 minutes, until white, black, or bubble water does not come out from the filter.
(*Water Flushing: A process of cleaning inside of the filter*)
- After replacing the carbon filter, black carbon dust may remain on the bottom of the unit.
(The carbon filter spills the dust making water taste quality and harmless.)

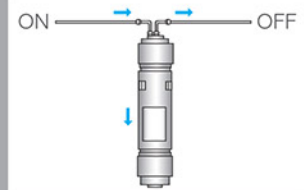

- According to the filter replacement cycle, replace filters regularly.
- If the filter is not replaced regularly, it could degrade the water quality.
- The filter replacement cycle may vary depending on feedwater quality and consumption.
- When replacing the filter, use our genuine one.
(If not, we can not guarantee filter efficiency and water quality.)

FILTER REPLACEMENT GUIDE

❖ Note: We can not take responsibility for any damage caused by replacing filters by a third party who is not our serviceman.



- When replacing filters, be sure to ask serviceman to do flushing process to new filters for more than 10 minutes. (If not, it could degrade water quality.)
- Even if your water consumption is not much, following regular filter replacement cycle is recommended.
- Above filter replacement cycles are based on normal feedwater condition and 1500 liters of filtered water efficiency. (The cycle does not mean quality guarantee period.)

HOT TANK & COLD TANK CLEANING

1. **Shut OFF** Water Supply Valve and unplug the power cord.
2. Drain all water in the Cold Tank by dispensing it from the Cold Water Nozzle.
3. Remove the lower panel to access the drain valve. And open the drain valve to drain the water completely.
(Drain valve is located on the lower left side of the front panel. Be careful when draining out the hot water as it may cause severe burns.)

4. Unscrew the two screws on the left and right at the back of the unit and remove the top cover. Then remove the Cold Tank Cover.
(Be careful not to damage the rubber packing when removing the Cold Tank Cover. Also, the Cold Tank is made out of stainless steel. Please use caution to prevent injury.)
5. Clean the cold tank by flushing it out with water.
(Make sure to close the drain valve when done.)
6. Open Water Supply Valve and check for any water leakage until the Cold Tank is full. Then, reassemble the top cover.
7. Monitor the unit for a day for any leakage. If there is any water leakage, please contact **OZEMCare** CCASSC immediately.

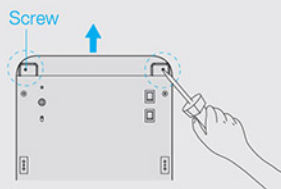

- Please contact **OZEMCare** CCASSC for a cleaning service if the unit has not been used for an extended period.

Do not attempt to do it by yourself. It may cause malfunction.

Cleaning Cycle

Cleaning	Cycle	Method
Exterior	Once a week	Clean the outer part with a non-abrasive soft cloth. <i>(Never use Benzene, gasoline, or thinner to clean the unit.)</i>
Drip Tray	Frequently	Clean the drip tray as frequently as possible with a sanitary wipe or solution.
Fitting/Tubing	At least once every 2 years	Check all fittings and tubing during filter changes. Replace fittings and tubing, if necessary.
Water Tap	Once a day	Unscrew the nozzle counterclockwise to separate it. Then, thoroughly clean the nozzle openings with a sterilized swab. After cleaning, screw the nozzle back on.



■ Convenient home water filtration system

Based on 4 people, capacity of 10L/day can be used more conveniently at home.

■ Water supply system is directly connected to home water-source plumbing.

Water is supplied with convenience and affordable price.

■ Thorough filtration system

- 1st Step **Sediment Filter** (removes contaminants)
- 2nd Step **Pre-Carbon Filter** (removes residual chlorine)
- 3rd Step **RO Filter** (removes bacteria and harmful organic chemicals)
- 4th Step **Post-Carbon Filter** (removes residual toxic gas composition and odor)

■ The safety-function of hot water operation

By overheating-protection heater (bimetal manual return) and automatic temperature control (bimetal automatic return), it is easy to use.

■ Automatic water level adjustment

Because the water level is automatically adjusted, filter life is increased as well as product durability.

■ Fresh drinking water supply

Cold-water (4°C-12°C) and hot water (70°C-90°C) can be used anytime. And by preventing from external dust and bacterial contamination, gives fresher water supply.

■ Modern design

The sensory, modern, and elegant design fits everywhere and stands out.

■ Power-saving features

If you use only cold water, turn off the hot water switch. You can reduce the electric rates of household by saving electricity cost.

■ Economic/practical advantages

Easy to install and easy to use.

TROUBLESHOOTING

- ❖ Please refer to the common troubleshooting solutions before contacting **OZEMCare** Customer Care & After-Sales Support Center (CCASSC).

Problem	Cause	Possible Solutions
Insufficiently heated water	Low power supply	Check voltage rate.
	Hot water switch off	Check to make sure that the Hot Water Switch at the back is turned ON .
Insufficiently chilled water	Low power supply	Check voltage rate.
	Cold water switch off	Check to make sure that the Cold Water Switch is turned ON .
No water comes out	Filter change needed	Check filter exchange schedule and please contact OZEMCare CCASSC.
	Water supply shut off	Unplug the power cord and plug it back in to restart the system.
	Connecting hose bending	Check the tubing to make sure that it is not bent or kinked to prevent water flow.
No heating	Shut down by temperature controller or heater malfunction.	After turning the Hot Water Switch OFF , please contact OZEMCare CCASSC. (When the water tank is overheated, the temperature controller cut off the power supply to a heater)
Abnormal hot and cold water temperature	Too much water consumption	When much water is continuously taken from the unit, hot and cold water temperature become abnormal. Do not take water from the water dispenser for 5~6 minutes, then you can take normal hot and cold water.

TROUBLESHOOTING

- ❖ Please refer to the common troubleshooting solutions before contacting **OZEMCare** Customer Care & After-Sales Support Center (CCASSC).

Problem	Cause	Possible Solutions
Noisy sound	Working sound of compressor	When the compressor is activated, it is normal to hear the sounds of the refrigerant flowing through the system.
Low water production	Filter need to be replaced.	Replace filters.
	Low pressure feed water	If low-pressure water is supplied to the unit, less amount of filtered water is produced.
Water leakage	Poor connection to water supply	Close the water supply valve and please contact OZEMCare CCASSC.
Unpleasant water taste or odor	Cold water tank need cleaning	Clean the cold water tank.
	Poor environment conditions	Replace all the filters and clean the cold water tank.
Particle in water	It is bubble caused by water dispensing	Wait about a minute for the bubbles from the water dispensing to settle. If there are solid particles in the water, please contact OZEMCare CCASSC.

SPECIFICATIONS

Product Name	OZEMTECH Röntgen RO Compact
Model Number	WH1122-1800CT-RO
Power Supply	AC 220-240V / 50Hz
Compressor	1/11 HP Sealed Type
Condenser	Wire Type
Motor Power Consumption	.7A / 90W
Refrigerant	R-134a
Cold Water Tank	STS 304, about 3 Liters
Cold Water Capacity	About 20 Cups at 4-12°C
Temperature Control	Thermostat (in cold)
Cooling	Forced Cooling Type
Heater Power Consumption	400-470W
Hot Water Tank	STS 304, about 1.4 Liters
Hot Water Capacity	About 10 cups at 70-90°C
Heater	SHEATH or BAND Type
Temperature Control (in Hot)	Bi-metal
Overheat Protection Device	Bi-metal
Power Cord Length	2m
Front Cover	ABS
Side Panel	EGI
Faucet	ABS
Filtration Type	UF
External Dimensions	10.2in (26cm) W X 19in (48.5cm) D X 19.4in (49.5cm) H
Product Weight	19kgs.
Recommended Water Consumption	10L / a day (4 people based)

Filtration System

Filtration System	Sediment Filter	✓
	Pre-Carbon Filter	✓
	RO Filter	✓
	Post-Carbon Block Filter	✓

❖ Exterior and specification of the unit could be changed for performance improvement.

❖ Filter replacement cycle could be changed depending on water consumption.

Serial No.

PRODUCT WARRANTY

Röntgen **RO** Compact | Model No. WH122-1800CT-RO

Date Manufactured

Date Purchased

Date Installed

Customer's Name

Address

Mobile/Telephone No.

Email

WARRANTY GUIDE

- 1 - The warranty period is 12 months from the date of purchase. The warranty covers repair or replacement of parts, and service free of charge. The replacement of unit is only for cases proven to be a factory defect.
- 2 - During the warranty period the following cases are exempted from coverage of warranty:
 - a - Malfunction caused by reckless or improper use.
 - b - Malfunction caused by natural disaster or fortuitous event.



[Find Awareness: eXplore Your Nature]

OZEMCare

Customer Care & After-Sales Support Center
Units I - K, Rizalina Building II, 1675 Quezon Avenue,
West Triangle, 1104 Quezon City, Philippines

FOR CUSTOMER ASSISTANCE/INQUIRIES:



(+63) 2 825 68777



(+63) 917 656 8777



ozemcare@ozemtech.net



ozemcares



ozemcares



ozemtech.net

MADE IN KOREA

Please read this manual for your safety and proper use. Keep this manual carefully.
It has the product warranty.